































TECHNISCHE SPEZIFIKATIONEN

| | |
|---------------------------------------------------------------------------------------------------------------------------------------------------------------------------------------------------------------------------------------------------------------------------------------------------------------------------------------------------------------------------------------------------------------------------------------------------------------------------------------------------------------------------------------------------------------|--------------------------------------------------------------------------------------------------------------------------------------------------------------------------------------------------------------------------------------------------------------------------------------------------------------|
|  RAHMEN Dusk 6061 Aluminium Stealth Evo, für e-Bike optimiertes Zero Suspension System, 150mm Federweg, Forward Geometry, integrierte und nicht herausnehmbare Batterie, Boost 12x148mm Hinterachse, konifiziertes Steuerrohr, einteilige Monoblock Wippe, HHG innen verlegte Leitungen und Züge, gedichtete "MAX Capacity" Lager, extra große 17mm Achsen, im Ausfallende integrierter Geschwindigkeitssensor. *Zusätzliche Batterie (extern) optional erhältlich |  GRÖßE S: 380mm / M: 420mm / L: 450mm / XL: 490mm |
|  DÄMPFER RockShox Deluxe Select R Debonair, 205x65mm, Einstellungen: Low-Speed Zugstufe, Luftdruck. Obere Befestigung: Trunnion, untere Lager 25x10mm |  GABEL RockShox 35 Silver TK 29, 160mm, TurnKey, Solo Air, konifiziertes Steuerrohr, Boost 15x110mm Achse, 35mm Stahl Standrohre, 44mm Offset. Einstellungen: Low-Speed Druckstufe bis Lock, Zugstufe, Luftdruck. |
|  STEUERSATZ Onoff Saturn konifiziert für 1-1/8" bis 1-1/2" Steuerrohr, gedichtete ACB Lager, oben 41x30,2x7x45°x45°, unten 51,9x40x8x45°x45° |  VORBAU Onoff Sulfur FG 30mm 0°, geschmiedetes 6061 Aluminium, 31,8mm Lenkerdurchmesser |
|  LENKER Onoff Sulfur 1.0, doppelt konifiziertes 6061 Aluminium, Erhöhung: 20mm, Breite: 780mm, 9° horizontale Kröpfung/Backsweep, 5° vertikale Kröpfung/Upsweep, 31,8mm Lenkerdurchmesser |  GRIFFE Onoff Diamond, lock-on einfach, 135mm |
|  SATTELSTÜTZE Onoff Pija versenkbar, interne Leitungsverlegung, Durchmesser 31,6mm, Größe S: 387x125mm, Größe M: 425x150mm, Größe L/XL: 465x170mm |  SATTEL FIZIK Terra Aidon X5 145mm |
|  BREMSE VORN Sram G2 R, 4-Kolben Bremssattel, einteilige 6-Loch Centerline 200mm Bremsscheibe, organische Bremsbeläge mit Rückplatte aus Stahl |  BREMSE HINTEN Sram G2 R, 4-Kolben Bremssattel, einteilige 6-Loch Centerline 200mm Bremsscheibe, organische Bremsbeläge mit Rückplatte aus Stahl |
|  BREMSHEBEL Sram G2 R, Griffweite werkzeuglos einstellbar |  FELGEN MDK-HP1 29, 30mm Innenbreite, Tubeless Ready, 32 Speichen |
|  SPEICHEN CN rund, Edelstahl |  NABE VORN Formula DC711, Boost 15x110mm, gedichtete Lager, IS 6-Loch |
|  NABE HINTEN Formula EHL148 Boost 12x148mm, gedichtete Lager, IS 6-Loch |  REIFEN VORN Maxxis Rekon 29x2.6, Tubeless Ready, Dual Compound, EXO Protection, 60TPI, faltbar |
|  REIFEN HINTEN Maxxis Rekon 29x2.6, Tubeless Ready, Dual Compound, EXO Protection, 60TPI, faltbar |  KURBELN FSA, 165mm |
|  KETTENBLÄTTER Sram X-Sync 2 Eagle 34Z, Stahl, Narrow-Wide, 104 BCD |  KETTE Sram SX Eagle, 12-Gang, Powerlock |
|  SCHALTWERK Sram SX Eagle, Roller Bearing Clutch Typ 3, Cage Lock, langer Käfig, 1x12-Gang, X-Actuation 1:1 |  SCHALTHEBEL Sram Trigger SX Eagle, 12-Gang, X-Actuation 1:1, Single Click |
|  KASSETTE Sram PG-1210, 11-50Z, 12-Gang |  SCHALTAUGE Mondraker M068 |
|  SONSTIGES *Optionale externe Batterie: Simplo 360Wh |  GEWICHT 23.8 kg |
|  DISPLAY Shimano STEPS E8000 |  MOTOR Shimano STEPS EP800 |
|  BATTERIE Simplo 630Wh, integriert | |



| | RAHMENHÖHE | S | M | L | XL |
|---|-----------------------|---------|---------|---------|---------|
| A | Sitzrohrlänge | 380 mm | 420 mm | 450 mm | 490 mm |
| B | Oberrohrlänge | 605 mm | 625 mm | 650 mm | 670 mm |
| C | Innenlagerabsenkung | -25 mm | -25 mm | -25 mm | -25 mm |
| D | Innenlagerhöhe | 350 mm | 350 mm | 350 mm | 350 mm |
| E | Kettenstrebenlänge | 455 mm | 455 mm | 455 mm | 455 mm |
| F | Sitzwinkel | 73,5° | 73,5° | 73,5° | 73,5° |
| G | Sitzwinkel (effektiv) | 76° | 76° | 76° | 76° |
| H | Lenkwinkel | 65,5° | 65,5° | 65,5° | 65,5° |
| I | Gabel Offset | 44 mm | 44 mm | 44 mm | 44 mm |
| J | Radstand | 1225 mm | 1245 mm | 1265 mm | 1285 mm |
| K | Steuerrohrlänge | 110mm | 110mm | 130mm | 130 mm |
| L | Reach | 450 mm | 470 mm | 490 mm | 510 mm |
| M | Stack | 622 mm | 622 mm | 640 mm | 640 mm |

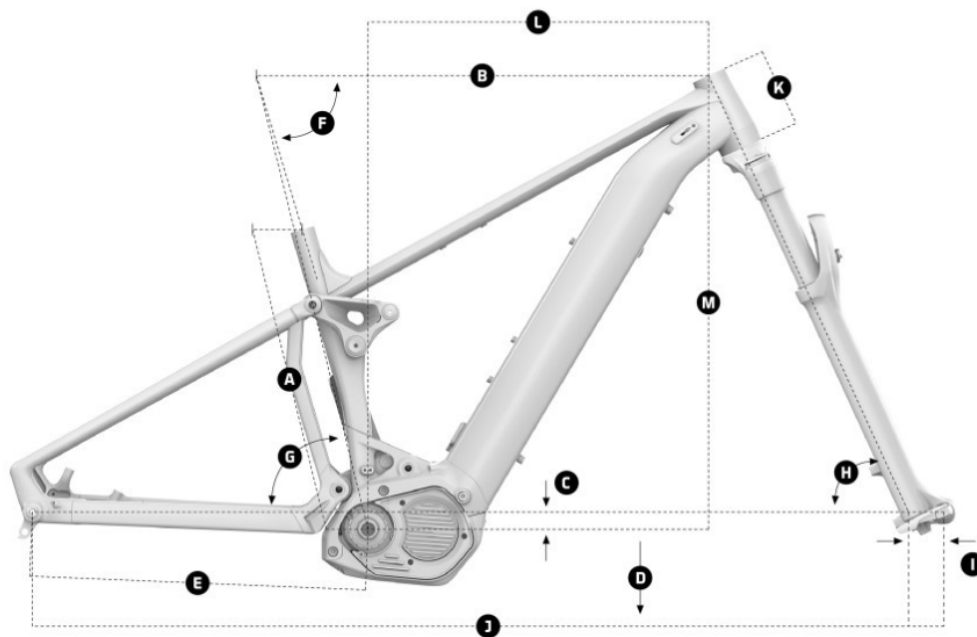