































TECHNISCHE SPEZIFIKATIONEN

 RAHMEN Crafty Stealth Air voll-Carbon, für e-Bike optimiertes Zero Suspension System, 150mm Federweg, Forward Geometry, integrierte Batterie, Boost 12x148mm Hinterachse, konifiziertes Steuerrohr, einteilige Monoblock Wippe, HHG innen verlegte Leitungen und Züge, gedichtete "MAX Capacity" Lager, extra große 17mm Achsen, im Ausfallende integrierter Geschwindigkeitssensor, exklusive Motorabdeckung aus Kunststoff.	 GRÖÖE S: 380mm / M: 420mm / L: 450mm / XL: 490mm
 DÄMPFER Fox Float-X LV Performance, 205x65mm. Einstellungen: Druckstufe über zweistufigen Hebel, Low-Speed Zugstufe, Luftdruck. Obere Befestigung: Trunnion, untere Lager 25x10mm	 DÄMPFEREINSTELLUNGEN Druckstufe: mittlere, Zugstufe: mittel, Volumen Spacer 0.2
 GABEL Fox 38 29 Float GRIP Performance, 160mm, optimiert für eBikes, konifiziertes Steuerrohr, Boost 15x110mm Achse, 44mm Offset, 68mm OD Gabelbrücke. Einstellungen: 3-stufige Druckstufe mit Micro Adjust, Low-Speed Zugstufe, Luftdruck	 STEUERSATZ Acros Custom für 1-1/2" Steuerrohr, Schrägkugellager 40x52x7, innen liegende Leitungsführung
 VORBAU Onoff Krypton FG 30mm, CNC, 31,8mm Lenkerdurchmesser	 LENKER Onoff Krypton 1.0, doppelt konifiziertes 6061 Aluminium, Erhöhung: 20mm, Breite: 800mm, 9° horizontale Kröpfung/Backsweep, 5° vertikale Kröpfung/Upsweep, 31,8mm Lenkerdurchmesser
 GRIFFE Onoff Diamond, lock-on einfach, 135mm	 SATTELSTÜTZE Onoff Pija versenkbar, interne Leitungsverlegung, Durchmesser 31,6mm, Größe S: 387x125mm, Größe M: 425x150mm, Größe L/XL: 465x170mm
 SATTEL FIZIK Terra Aidon X5 145mm	 BREMSE VORN Sram G2 RS, 4-Kolben Bremssattel, einteilige 6-Loch Centerline 200mm Bremsscheibe, organische Bremsbeläge mit Rückplatte aus Stahl
 BREMSE HINTEN Sram G2 RS, 4-Kolben Bremssattel, einteilige 6-Loch Centerline 200mm Bremsscheibe, organische Bremsbeläge mit Rückplatte aus Stahl	 BREMSHEBEL Sram G2 RS, SwingLink und kugelgelagerte Bremshebel, werkzeuglose Einstellung von Griffweite und Kontaktpunkt
 FELGEN Mavic E-Deemax 29, 30mm Innenbreite, geschweißt, PFR, Tubeless Ready, 28 Speichen	 SPEICHEN Mavic J-Bend, doppelt konifiziert, kontaktlos gekreuzt
 NABE VORN Mavic Boost 15x110mm, IS 6-Loch	 NABE HINTEN Mavic Boost 12x148mm, ID360 Ratchet System, IS 6-Loch
 REIFEN VORN Maxxis Minion DHF 29x2.6, Tubeless Ready, 3C MAXX TERRA, EXO+ Protection, 120TPI, faltbar	 REIFEN HINTEN Maxxis Minion DHR II 29x2.6, Tubeless Ready, 3C MAXX TERRA, EXO+ Protection, 120TPI, faltbar
 KURBELN Race Face Aeffect e-Bike, 165mm	 KETTENBLÄTER Sram X-Sync 2 Eagle 34Z, Aluminium, Narrow-Wide, 104 BCD
 KETTE Sram NX Eagle, 12-Gang, Powerlock	 SCHALTWERK Sram GX Eagle, Roller Bearing Clutch Typ 3, Cage Lock, 1x12-Gang, X-Actuation 1:1
 SCHALTHEBEL Sram Trigger NX Eagle, 12-Gang, X-Actuation 1:1, Single Click	 KASSETTE Sram XG-1230, 11-50Z, 12-Gang
 SCHALTAUGE Mondraker M068	 GEWICHT 23.7 kg
 DISPLAY Bosch Kiox 300	 MOTOR Bosch Performance Line CX Cruise (25Kmh/h) GEN4 BS3
 BATTERIE Bosch Powertube 750Wh	



	RAHMENHÖHE	S	M	L	XL
A	Sitzrohlänge	380mm	420mm	450mm	480mm
B	Oberrohrlänge	605mm	625mm	650mm	670mm
C	Innenlagerabsenkung	-25mm	-25mm	-25mm	-25mm
D	Innenlagerhöhe	350mm	350mm	350mm	350mm
E	Kettenstrebenlänge	455mm	455mm	455mm	455mm
F	Sitzwinkel	73.5°	73.5°	73.5°	73.5°
G	Sitzwinkel (effektiv)	76°	76°	76°	76°
H	Lenkwinkel	65.5°	65.5°	65.5°	65.5°
I	Gabel Offset	44mm	44mm	44mm	44mm
J	Radstand	1225mm	1245mm	1265mm	1285mm
K	Steuerröhlänge	110mm	110mm	130mm	130mm
L	Reach	450mm	470mm	490mm	510mm
M	Stack	622mm	622mm	640mm	640mm

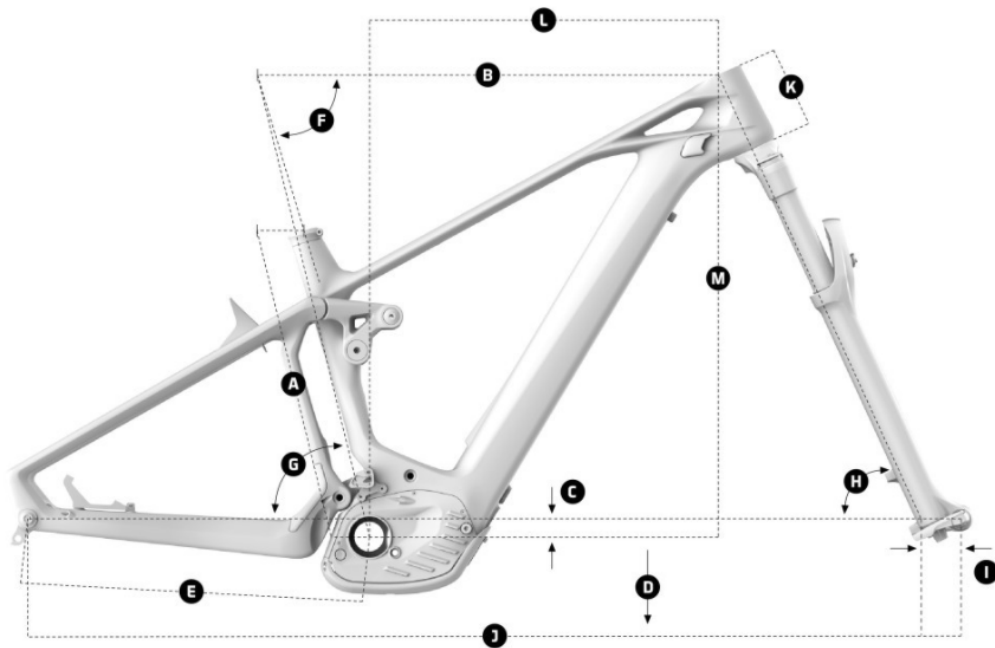